



KONICA MINOLTA

DIRECT DIGITIZER

REGIUS MODEL 210



REGIUS
MODEL 210



KONICA MINOLTA

KONICA MINOLTA MEDICAL & GRAPHIC, INC.

No.1, Sakura-machi, Hino-shi, Tokyo, 191-8511, Japan

Distributed by :

The essentials of imaging

REGIUS

MODEL 210

**All-around system that achieves
maximum productivity in various environments,
succeeding the “Super Distribution System” concept
from REGIUS MODEL 170.**

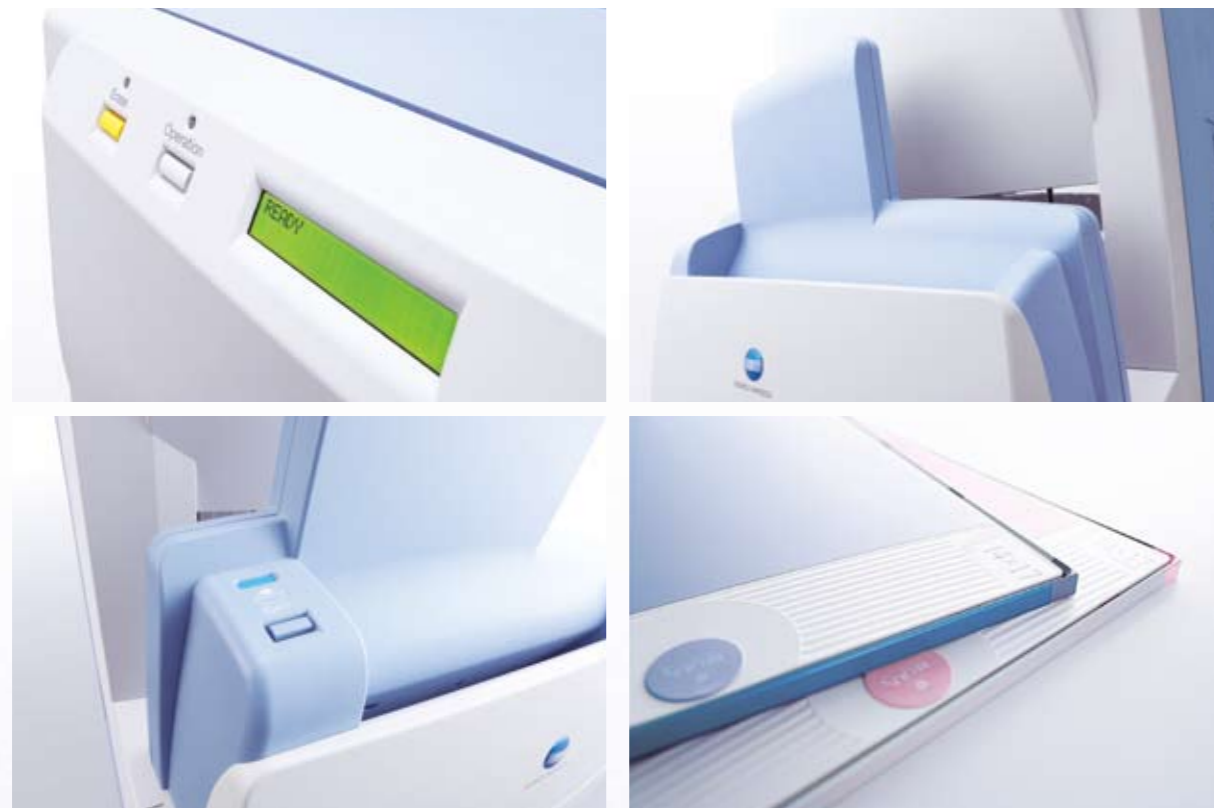

**The system offers a $43.75\mu\text{m}^*$ read function for mammography;
with new, enhanced console features.**

**C-PLATE series cassette with columnar crystal phosphor is ideal
for mammography and pediatric use.**

**Introducing the New-Generation REGIUS
easier to use, ever more sophisticated.**

* Option license



KONICA MINOLTA

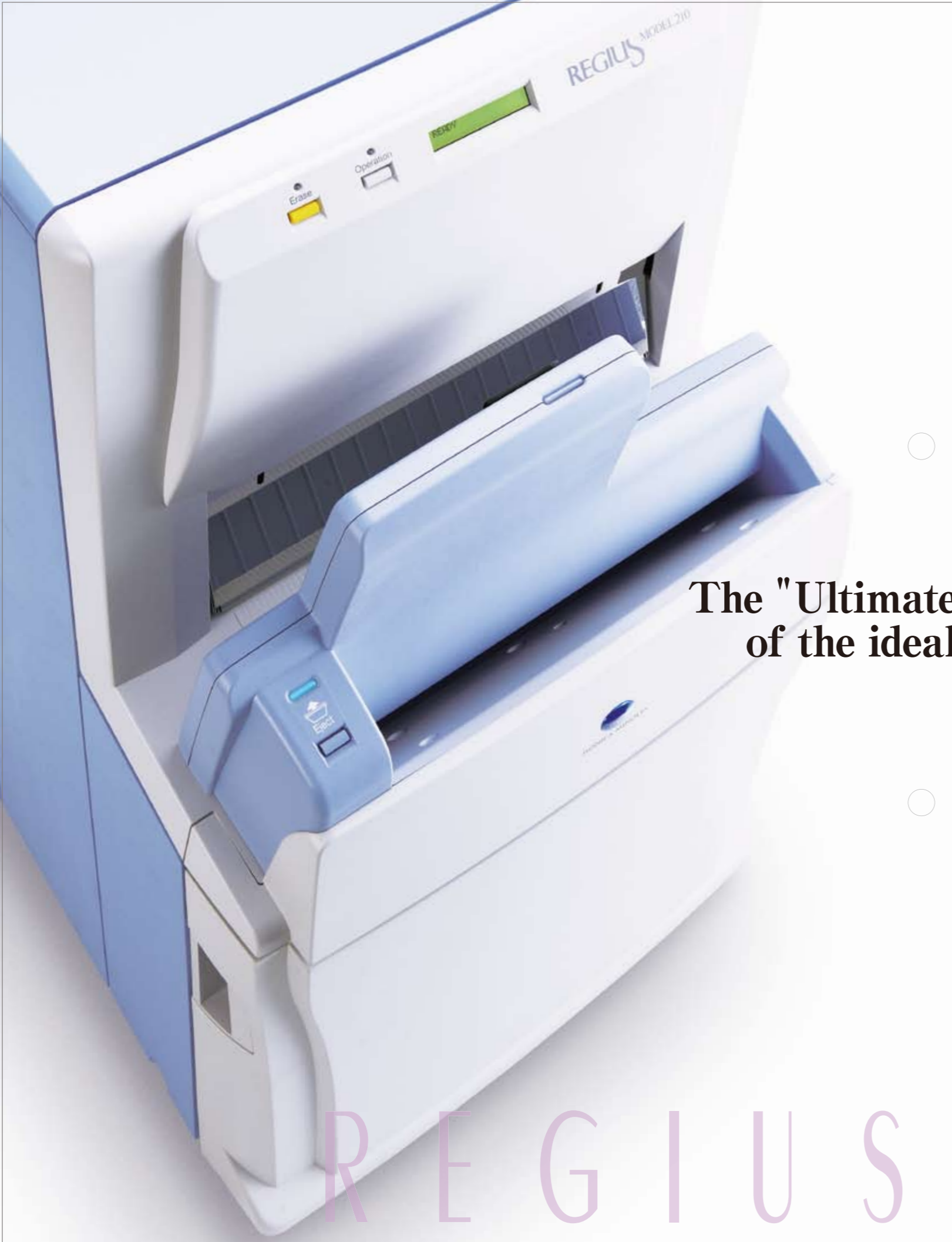

REGIUS MODEL 210

Erase

Operation

READY

The "Ultimate Resource Sharing" concept enables realization of the ideal workflow in any scene of the medical institute.

A new Compact, high-performance design.

Utilizing a unique dual bay design, the high speed reader of REGIUS Model 210 processes up to 100 plates per hour for maximum performance. This next generation reader radically improves workflow all within a mere 58×58 cm footprint.



Centralized image checking for flexible layout

The "Ultimate Resource Sharing" concept provides the flexibility to separate the location of the consoles and the readers. This allows for the same fast and thorough image checking as with conventional systems. The result : system layout and productivity are optimized according to the number of examinations conducted, the work line and floor space.

■ Ultimate Resource Sharing Concept

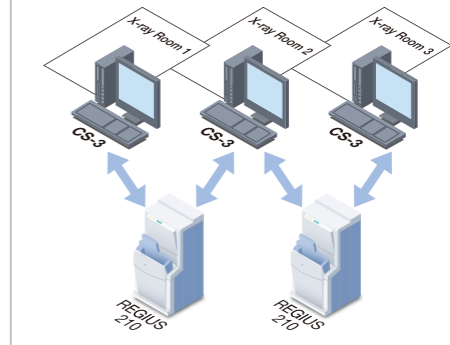

Side panel for optical unit maintenance.

MODEL 210 has a side panel for the cleaning / maintenance of optical unit. Simply open the panel and pull out the cleaning knob for easy cleaning of the optical unit. Fine dust accumulated on the optical unit can be easily removed.



Two selectable options for cassette registration.

Cassette registration mode can be selected from two options, registration at imaging (barcode registration) and registration at reading (screen menu selection), according to the line of movements and system layout. This enables more flexible operation. Two types of bar code readers are available; single-type (above in photo) or multi-type.

REGIUS MODEL 210



REGIUS CONSOLE CS-3

CS-3 incorporates a user interface similar to that of CS-1. Both are highly regarded for their intuitiveness and simplicity. CS-3 provides the user flexibility in system configuration needed to create the ideal workflow. The unit is also equipped with a User Tool that gives complete freedom to customize image settings.



REGIUS CONSOLE CS-2

The CS-2 console used for the REGIUS Series is designed to provide the user with even greater ease and simplicity of operation. With the aim of offering a console that can be operated by anyone immediately after installation, only the most essential functions are incorporated into the CS-2 user interface. At the same time, various automated processing functions have been incorporated into CS-2 to create a highly efficient environment.

Choose the Console for your Ideal Environment

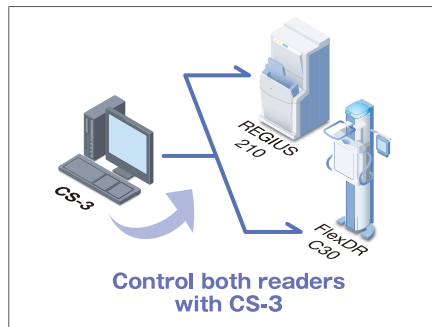

Multi-reader control.

One CS-3 unit seamlessly controls both reader units of the Model 210 and FlexDR C30. For superior processing continuity, the flow of exposures is uninterrupted while the images are acquired.

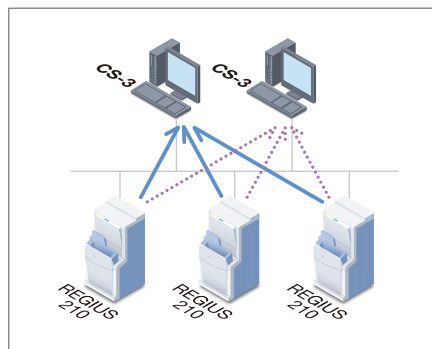

Images are always displayed on the CS-3 where the plate is registered, regardless of which reader was used to scan the plate. This makes it easier for the operator to check image quality while maximizing the reader utilization.



A better real-time display.

Shorter time from exposure to image checking is important for the user's efficiency. The CS-3 makes it possible to check the image in the least amount of time possible, since images are displayed in real time.



User Tool

This tool allows the user to modify processing parameter settings, examination key layout, and other settings with ease. The operation is highly visually oriented: users can browse previous images while using slide bars to change the settings; images are then updated as the settings change. The drop and drag function for creating examination keys are also intuitive and simple to use.

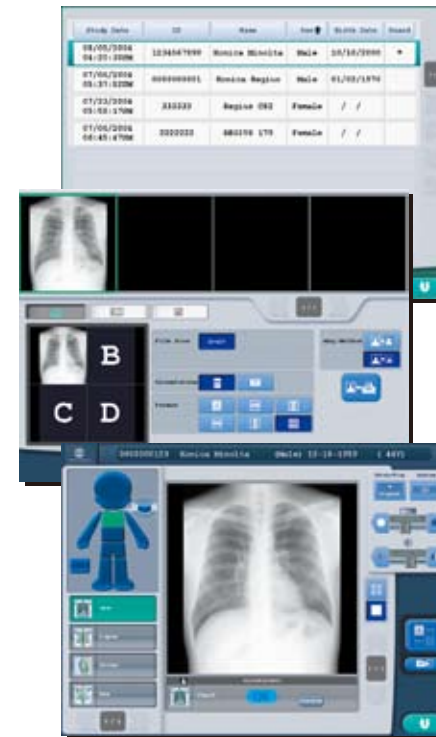

Easy User Interface (Easy GUI)

CS-2 allows the user to select the body part to be examined from the icon. Simplified screen operations, from patient registration to image verification are achieved by various automated processing function.

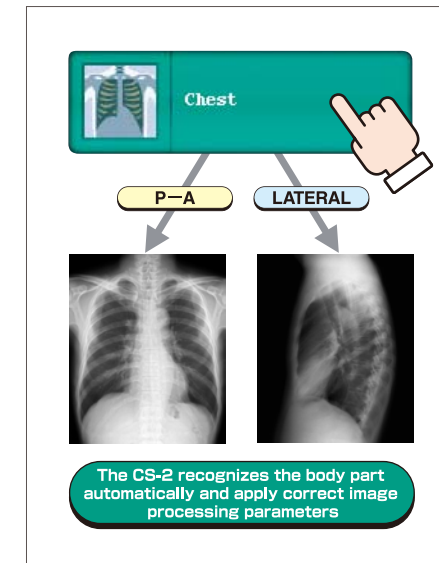

Automatic Body Part Recognition.

A comprehensive analysis of shape and density variations in the body part, and of the edge and continuity of bones, enable the CS-2 to produce an optimal image without the need for creating specific exam tag key settings.

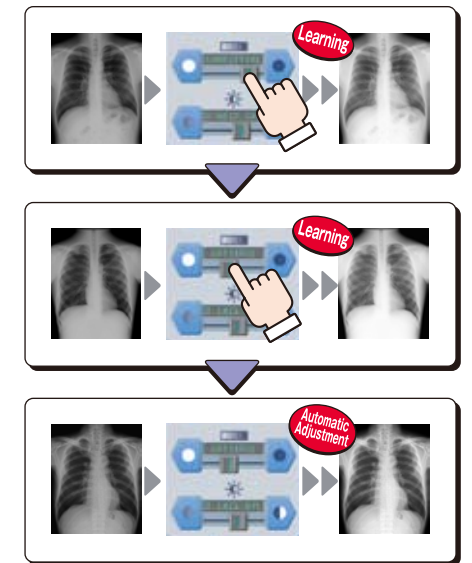

Automatic Processing Parameter Learning Function.

The CS-2 automatically memorizes preferred density and contrast adjustments made by the users and regularly calculates the average numbers for these settings. As a result, CS-2 automatically customizes image quality to match users' preference.

C O N S O L E

MAMMOGRAPHY & BABIES



C-PLATE series with vapor deposition-type phosphor layer

"C-PLATE" features a columnar crystal phosphor layer that efficiently delivers photostimulated luminescence to the light reception unit. A high X-ray absorbing material is used as phosphor to achieve excellent sharpness and granularity. In addition to the cassette for mammography, cassette for pediatric use is now available that best meets the requirement for a reduced radiation dose.

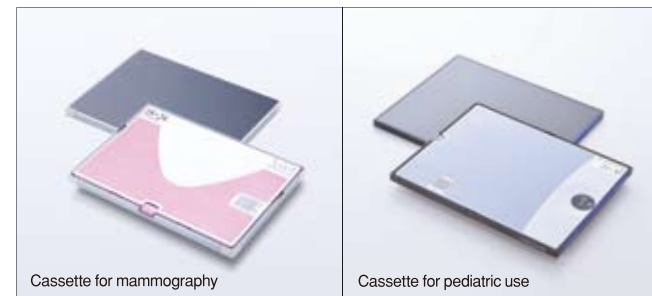

Optimum read function for different body parts

In addition to the 175 and 87.5 μm read capability, REGIUS MODEL 210 supports 43.75 μm * read function for mammography and 87.5 μm read function for pediatric use. In mammography where recognition of subtle pathological changes is essential, highly valuable images can be achieved based on a vast amount of information.

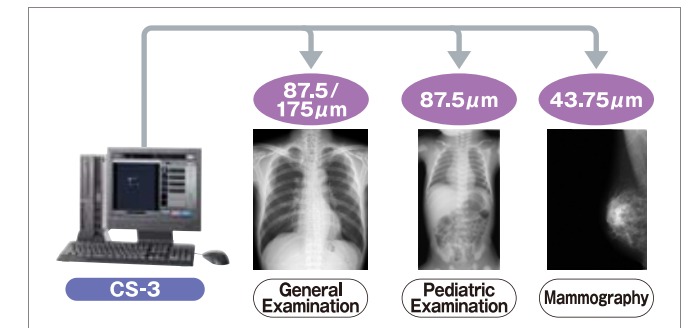

Sampling pitch of 43.75 μm * for digital mammography reading.

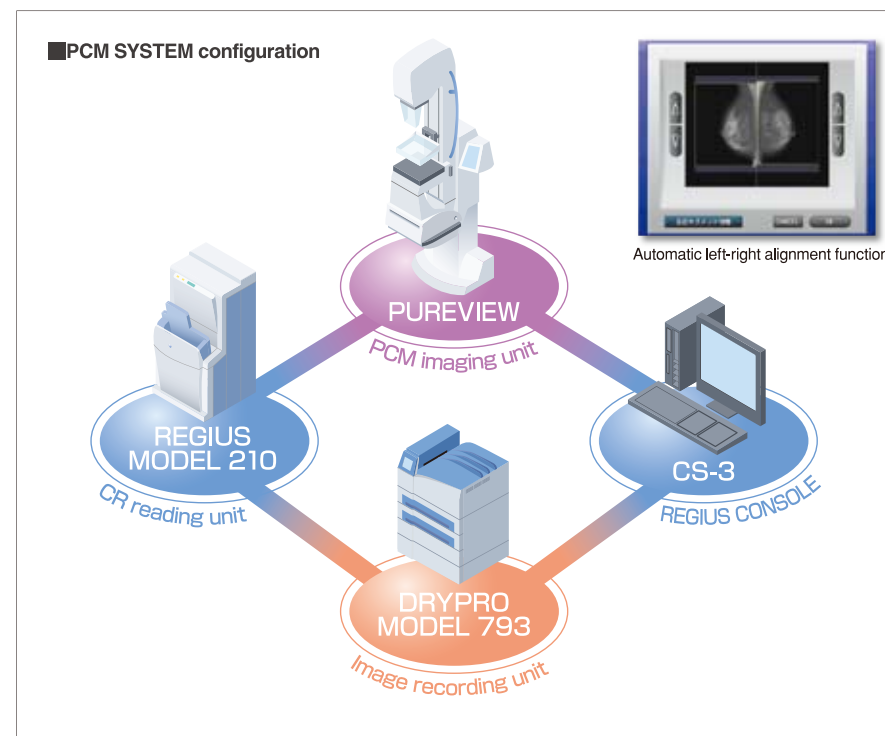

Mammography system PCM SYSTEM

PCM SYSTEM is the world's first mammography system utilizing phase contrast technology. Ultrahigh density imaging data are obtained by a half-cut size cassette for PCM and the 43.75 μm * read function. Highest-quality images with excellent sharpness and granularity are produced through the combination of film output to the original size and the use of highest-concentration 4.0 film.

Left and right breast images are displayed after vertical adjustment by automatic left-right alignment function.

Fine vertical positioning can also be manually achieved on the screen.

★ Screen design may be subject to change without prior notice for the purpose of performance improvement.

S P E C I F I C A T I O N S

Direct Digitizer REGIUS MODEL210

Exposure size

14"X17" / 14"X14" / 11"X14" / 10"X12" / 8"X10" /
18X24 cm / 24X30 cm / 15X30 cm and others

Sampling Pitch

3Types : 87.5 / 175 and 43.75 μ m* for Mammography

Maximum Resolution

4020X4892 (14"X17" / 87.5 μ m)
5440X6776 (24X30cm / 43.75 μ m / Mammography)
7080X9480 (14"X17" / 43.75 μ m / PCM)

Digital Gradation Level

4096 levels (12bit)

Processing Capability

approx. 100 plates / hour (14"X14" / 175 μ m)

Cassette Feed/Load Time or Cassette Cycle Time

approx. 35 seconds (14"X14" / 175 μ m)

Slots

InsertX1 (plus 1 stack)
EjectX1 (4-stack)

Outer Dimensions/Weight

W580XD580XH1230mm/approx. 170kg

Power Consumption

AC100/115/120/200/220/230/240V \pm 10%
50/60Hz approx. 1.1kW

Operating Conditions

Temperature : 15-30°C
Humidity : 35-80%RH (no condensation)

* Option license

REGIUS MODEL210 Outer Dimensions

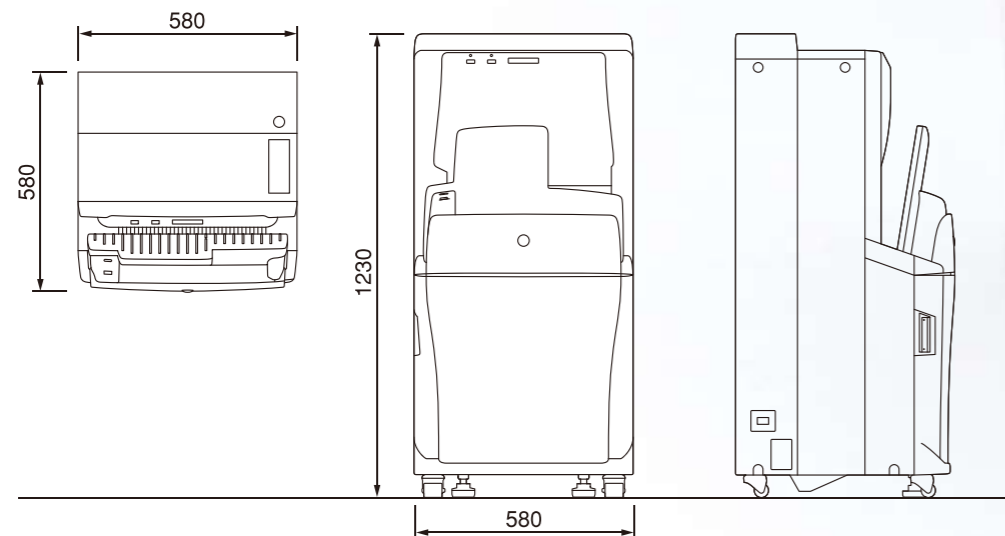

Unit : mm 1/20 scaled



REGIUS Console CS-3

Image Processing

Automatic Gradation Processing (G Processing)
Frequency Processing (F Processing)
Equalization Processing (E Processing)
Hybrid Processing (H Processing)

Image Output

• Maximum
Host : 3ch for normal, 1ch for backup
Printer : 2ch for normal, 1ch for backup
• CS-3 Standard Software
Host or Printer : 1ch for normal, 1ch for backup

DICOM Support

Basic Grayscale Print Management (SCU)
Storage (SCU)
Modality Worklist Management
Modality Performed Procedure Step
Grayscale Standard Display Function (print output)

Maximum Connection

REGIUS 190/210 16units and FlexDR C30 1unit



Output Format

1X1, 2X1, 1X2

Main Options

• Hardware option
Bar Code Reader for Cassette Registration
CS-1 PDA
CS-1 PDA CRADLE
IDS WW
• Software option
CS-3 MWM/FTP/DETACHED Option
CS-3 MPPS/DETACHED Option
CS-3 HQ Mammography Option
CS-3 DICOM Output Additional#1
CS-3 DICOM Output Additional#2
CS-3 DICOM Output Additional#3
CS-3 DICOM Output Additional#4
CS-3 DICOM Output Package
CS-3 Stitching Option
CS-3 Image Sharing Option
CS-3 Data Analysis Option

REGIUS Console CS-2

Image Processing

Automatic Gradation Processing (G Processing)
Frequency Processing (F Processing)
Equalization Processing (E Processing)
Hybrid Processing (H Processing)

Image Output

• Maximum
Host : 2ch for normal, 1ch for backup
Printer : 1ch for normal, 1ch for backup
• CS-2 Standard Software
Host or Printer : 1ch for normal, 1ch for backup

DICOM Support

Basic Grayscale Print Management (SCU)
Storage (SCU)
Modality Worklist Management
Modality Performed Procedure Step
Grayscale Standard Display Function (print output)

Automatic Image Processing Function

Automatic Body Part Recognition
Automatic Processing Parameter Study

Maximum Connection

REGIUS 190/210 2units



Output Format

1X1, 2X1, 1X2, 2X2

Main Options

• Hardware option
Bar Code Reader for Cassette Registration
IDS WW
• Software option
CS-2 MWM/FTP/DETACHED Option
CS-2 MPPS/DETACHED Option
CS-2 HQ Mammography Option
CS-2 DICOM Output Additional#1
CS-2 DICOM Output Additional#2
CS-2 DICOM Output Package
CS-2 Stitching Option
CS-2 Image Sharing Option
CS-2 Data Analysis Option